

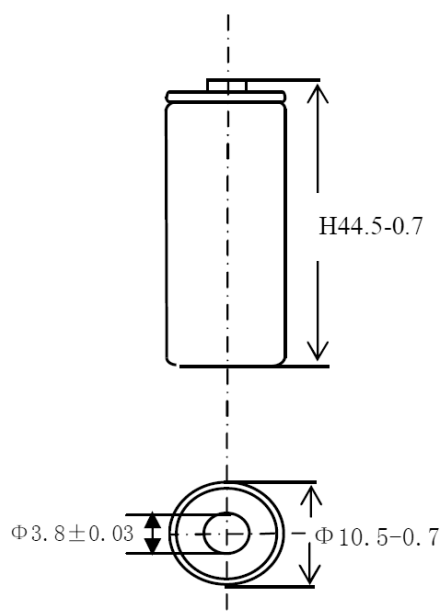

Ni-MH "Ready to Use" Rechargeable Battery R03 AAA 1000 mAh



Designation IEC:	HRL03
Nominal voltage:	1.2V
Designed capacity:	1000 mAh
Typical capacity:	950 mAh (IEC 61951-2, 7.3.2)
Cycle life:	>500 according to IEC standard
Standard charge:	95 mA / 16 h
Internal impedance:	≤35 mΩ (fully charged)
Weight:	14.5 g
Dimensions:	44.5 x 10.5 mm
Temperature ranges:	long-term storage: -20..35°C application/discharge: -20..50°C charge: 0..45°C

Discharge characteristics (load 0.2C – 190 mA):

Voltage (V)

